

# INSTALLATION INSTRUCTIONS



## IMPORTANT

Before installing your Lights.com fixture, please make sure that you carefully read through these instruction sheets. Consider having your fixture installed by a qualified licensed electrician.

**NOTE:** The important safeguards and instructions that appear in this manual are not meant to cover all possible conditions and situations that may occur. It must be understood that common sense, caution and care, are factors that can't be built into any product. This approach must be used by the person(s) caring for and operating the fixture.

## GENERAL INFORMATION

All electrical connections must be made in accordance with all ordinances, and Local and National Electrical Codes. These fixtures are intended for mounting to a standard 4" junction box. The box must be directly supported by the building structure and be ETL or U.L. Recognized.

## STEP BY STEP INSTRUCTIONS

Before starting your installation, disconnect the power by turning off the circuit breaker or by removing the fuse at the fuse box. **Just turning the light off at the light switch is not sufficient to prevent electrical shock.**

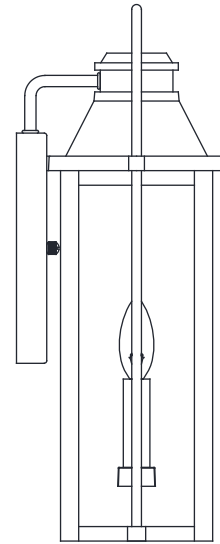

## COLLECTION

Preston

## APPLICATION

Outdoor Wall Light

## MODEL NO.

LC005297

LC005298

## WHAT WE PROVIDE

- Wall Light
- Mounting Plate
- Mounting and Wiring Hardware

## WHAT YOU NEED

- Phillips head Screwdriver
- Wire Cutters
- Wiring Supplies as Specified by Electrical Code
- Electrical Tape
- 2 x 60W E12 Bulbs

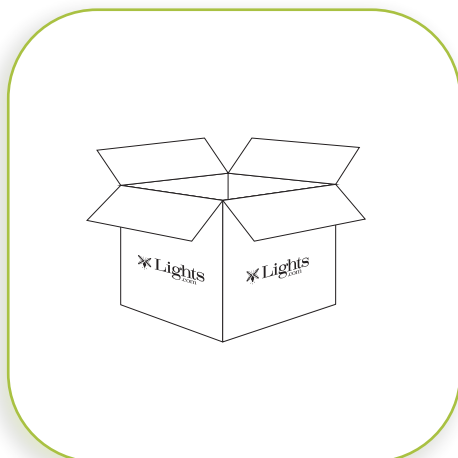

# 1

## UNPACK YOUR FIXTURE

Carefully set aside all parts and pieces.

## INSTALLATION INSTRUCTIONS

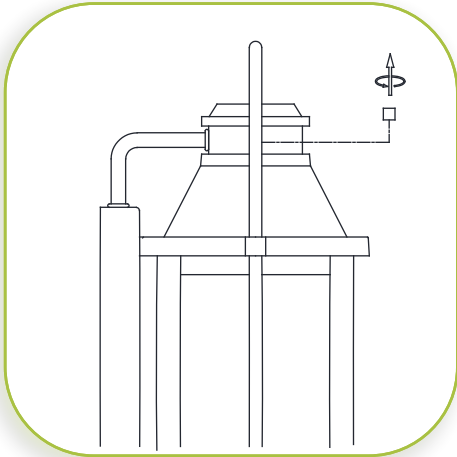

# 2

### PREPARE FIXTURE

Remove the cover from the cage by removing the screws from the top cover.



# 3

### INSTALL THE MOUNTING PLATE

**NOTE: This fixture can only be mounted vertically.**

If there is an existing fixture, remove it. Expose the supply wires from the J-Box. Insert supply wires through the mounting bar. Secure the mounting bar using the two Phillips head screws provided. Tighten to secure.

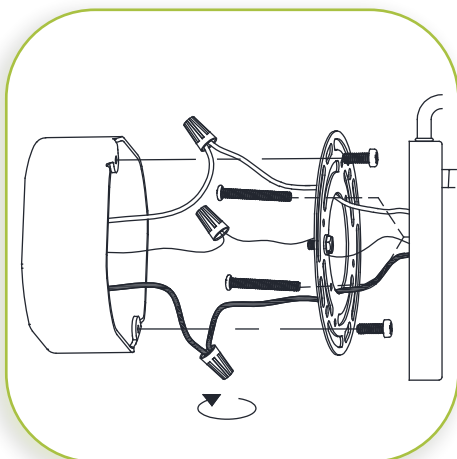

# 4

### MAKE WIRE CONNECTIONS

Connect the BLACK fixture wire to the BLACK supply wire and connect the WHITE fixture wire to the WHITE supply wire. Connect the fixture GROUND wire to the J-Box GROUND wire, or wrap around one of the protruding screws on the mounting plate. Secure all connections with the supplied wire nuts and electrical tape (not supplied).

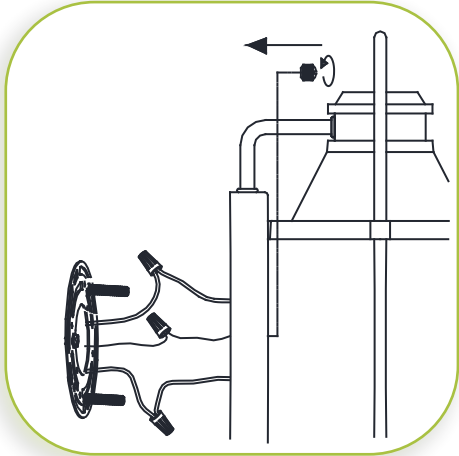

# 5

### CONNECT FIXTURE TO MOUNTING PLATE

Position the backplate over the mounting plate. Align the screws from the mounting plate with the two holes on the backplate and secure with the ball knobs supplied.

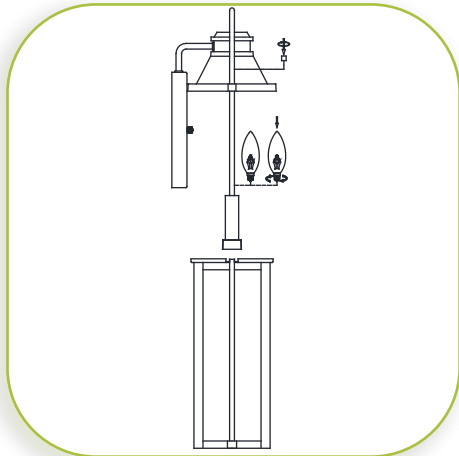

# 6

### INSTALL BULB AND COVER

Install your E12 60W Bulbs. Then re-attach the cover to the cage with the screws to secure.

**MAXIMUM WATTAGE 60W. DO NOT EXCEED THE WATTAGE AS STATED ON THE WARNING LABEL.**

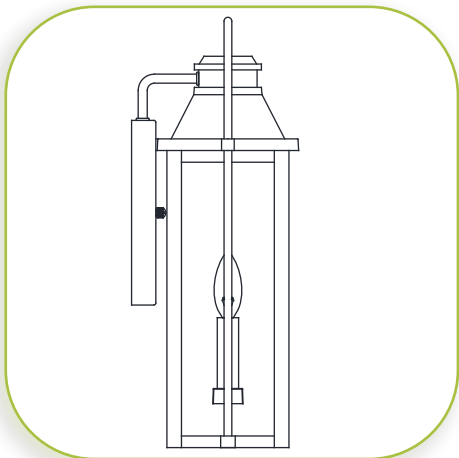

# 7

### RESTORE THE ELECTRICITY AND CHECK THE OPERATION OF YOUR NEW FIXTURE



### DIMMER NOTE

For the best lighting experience, we recommend using a dimmer. Not only does this allow you to create a great ambiance, it allows for energy savings and extends the life of the bulbs.