

# INSTALLATION INSTRUCTIONS



## IMPORTANT

Before installing your Lights.com fixture, please make sure that you carefully read through these instruction sheets. Consider having your fixture installed by a qualified licensed electrician.

**NOTE:** The important safeguards and instructions that appear in this manual are not meant to cover all possible conditions and situations that may occur. It must be understood that common sense, caution and care, are factors that can't be built into any product. This approach must be used by the person(s) caring for and operating the fixture.

## GENERAL INFORMATION

All electrical connections must be made in accordance with all ordinances, and Local and National Electrical Codes. These fixtures are intended for mounting to a standard 4" junction box. The box must be directly supported by the building structure and be ETL or U.L. Recognized.

## STEP BY STEP INSTRUCTIONS

Before starting your installation, disconnect the power by turning off the circuit breaker or by removing the fuse at the fuse box. **Just turning the light off at the light switch is not sufficient to prevent electrical shock.**

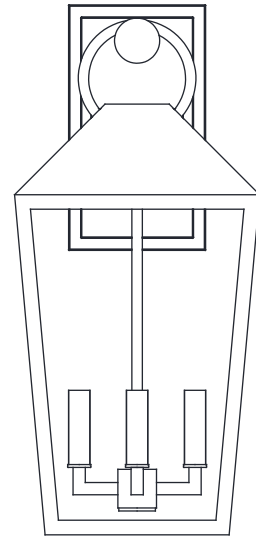

## COLLECTION

Cole

## APPLICATION

Outdoor Wall Light

## MODEL NO.

LC005367

LC005446

## WHAT WE PROVIDE

- Wall Light
- Mounting & Wiring Hardware
- 4 Glass Panels

## WHAT YOU NEED

- Phillips head Screwdriver
- Wire Cutters
- Wiring Supplies as Specified by Electrical Code
- Electrical Tape
- 4 X 60W E12 Bulbs

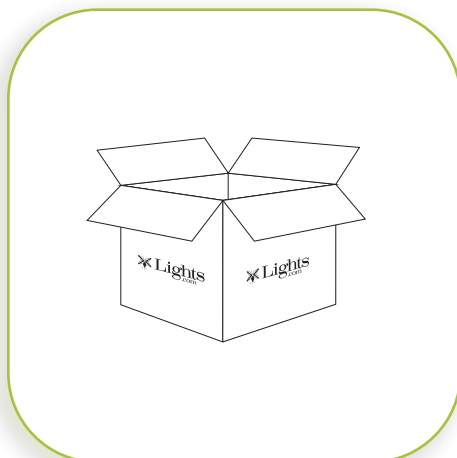

# 1

## UNPACK YOUR FIXTURE

Carefully set aside all parts and pieces.

## INSTALLATION INSTRUCTIONS

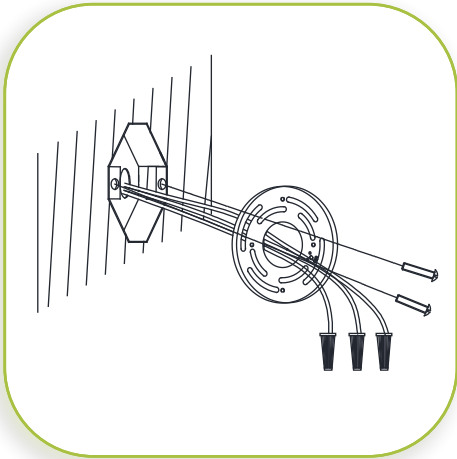

# 2

### INSTALL THE MOUNTING PLATE

**NOTE:** This fixture can only be mounted vertically.

If there is an existing fixture, remove it. Expose the supply wires from the J-Box. Insert supply wires through the mounting plate. Secure the mounting plate using the Phillips head screws provided. Tighten to secure.

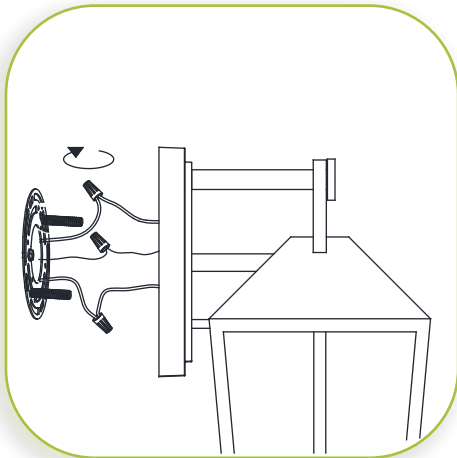

# 3

### MAKE WIRE CONNECTIONS

Connect the BLACK fixture wire to the BLACK supply wire and connect the WHITE fixture wire to the WHITE supply wire. Connect the fixture GROUND wire to the J-Box GROUND wire, or wrap around one of the protruding screws on the mounting plate. Secure all connections with the supplied wire nuts and electrical tape (not supplied).

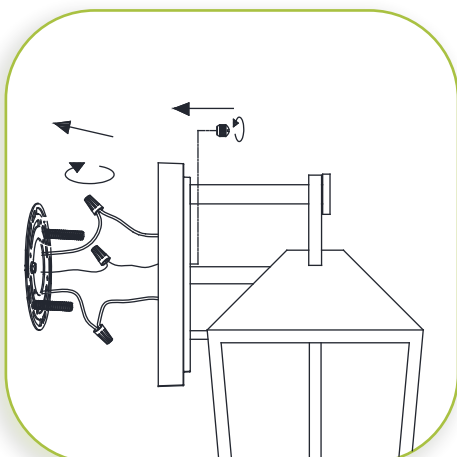

# 4

### CONNECT FIXTURE MOUNTING PLATE

Position the fixture body over the mounting plate. Secure the fixture body to the mounting plate with the two screws on the front.

# INSTALLATION INSTRUCTIONS

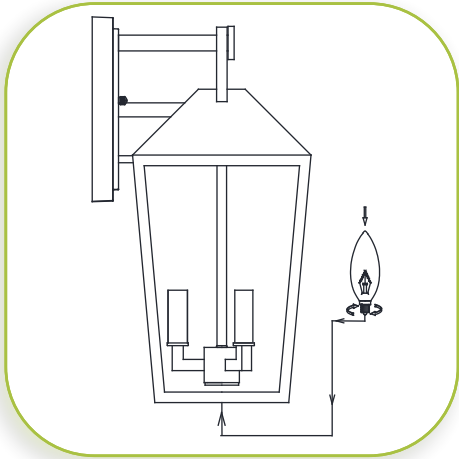

# 5

## INSTALL BULB

Install the E12 bulbs through the bottom of the cage.

**MAXIMUM WATTAGE 60W. DO NOT EXCEED THE WATTAGE AS STATED ON THE WARNING LABEL.**

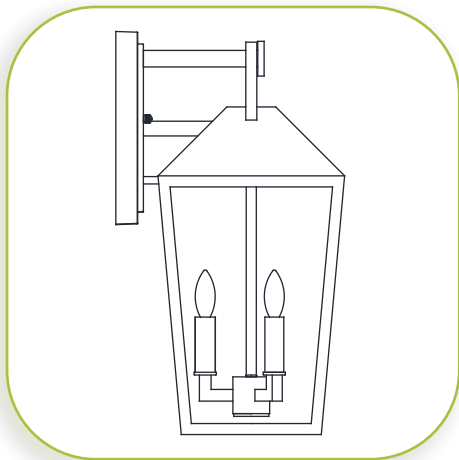

# 6

## RESTORE THE ELECTRICITY AND CHECK THE OPERATION OF YOUR NEW FIXTURE

### CAUTION

Please ensure that the fitting is cool and switched off before replacing the bulb. DO NOT use bulbs that might exceed the maximum wattage, stated on caution label.

## DIMMER NOTE

For the best lighting experience, we recommend using a dimmer. Not only does this allow you to create a great ambiance, it allows for energy savings and extends the life of the bulbs.